



PHOTOVOLTAIC TESTERS

VERIFICATION PHOTOVOLTAIC FIELD

PERFECTION FOR THE SUN

New HT solutions for performance optimization and troubleshooting.

Thanks to the decrease in the cost of components and the remarkable increase of performance, installing photovoltaic systems on the roof or on the ground has become increasingly common. In a photovoltaic system, problems connected to safety and to the system's performance must be checked, and maintenance of strings and single panels must be carried out.



Troubleshooting

- It may happen that, during the operation of a system, **some modules may jeopardize the performance** of the whole system. When system efficiency is lower than expected, it is necessary **to detect the defective modules** so that they can be replaced. This is obtained by measuring the I-V curve with devices **I-V400w** (for DC voltage up to 1000V) **SOLAR I-Ve** and **I-V500w** (for DC voltage up to 1500V).

Commissioning Tests

- When **operating** a photovoltaic system, it is necessary to **certify its safety according to IEC62446**. The suitable device to carry out these verifications is **PVCHECKs**.

Performance

- Performance **Recording** is one of the **necessary requirements** to make **maintenance programs efficient**. By monitoring system performance it is possible to **certify a production loss** quickly and efficiently. **SOLAR300N**, **SOLAR I-Ve** and **MPP300** are the **ideal solution for recording over time the production of a system** and the **performance check of an inverter**.

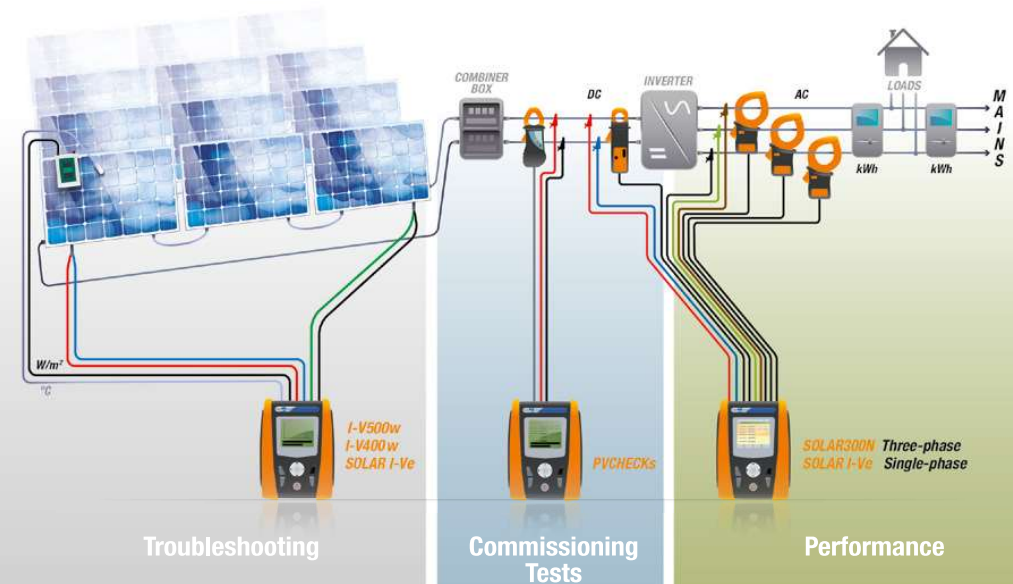

PHOTOVOLTAIC TESTERS



I-V500w I-V400w SOLAR I-Ve SOLAR300N PVCHECKs MPP300

MAINTENANCE AND EFFICIENCY OF THE PHOTOVOLTAIC SYSTEM

	MAINTENANCE		MAINTENANCE AND EFFICIENCY			
Measurement of I-V curve on PV modules and strings	•	•	•	-	-	-
Automatic measurement with AutoSequence™ mode	•	•	•	-	-	-
Quick IVCK test for measuring Voc and Isc on PV modules and strings	•	•	•	-	•	-
Single-phase/three-phase photovoltaic systems* testing	-	-	• 1MPPT (3MPPT with MPP300)	• 1MPPT (3MPPT with MPP300)	-	•
Continuity of protective conductors with 200mA	-	-	-	-	•	-
PV strings/field insulation with no service interruption with test voltage 250, 500, 1000V DC	-	-	-	-	•	-
DC side efficiency of the photovoltaic field	-	-	-	•	•	-
Use of remote unit SOLAR-Q2 with USB \ RF connection	• RF	• RF	• RF	• USB	• RF	• RF • USB
Measurement of irradiation with reference cell	•	•	•	•	•	-
Temperature measurement of cell and environment	•	•	•	•	•	-

MAINS ANALYSIS

AC/DC voltage in single-phase/three-phase systems	-	-	-	•	• DC	•
AC/DC current in single-phase/three-phase systems	-	-	-	•	• DC	•
Cosphi, Power Factor	-	-	-	•	-	-
Voltage unbalance (NEG%, ZERO%)	-	-	-	•	-	-
Active P, Reactive Q, Apparent S Power/Energy	-	-	• Only active P	•	• Only active P	-
Voltage and current harmonics up to the 49 th with calculation of THD%	-	-	-	•	-	-
Voltage anomalies (dips, peaks) with a resolution of 10ms (@ 50Hz)	-	-	-	•	-	-
Voltage spikes with a resolution of 5µs (200kHz)	-	-	-	•	-	-
Electric motor starting current (INRUSH)	-	-	-	•	-	-
Voltage flickers (Pst, Pbt)	-	-	-	•	-	-
Full analysis EN50160	-	-	-	•	-	-
Phase sequence	-	-	-	•	-	-
Neutral-Ground Voltage	-	-	-	•	-	-
Neutral current	-	-	-	•	-	-

MEMORY AND RECORDING

Max number of simultaneously selectable parameters	-	-	9	251	5	-
Recording with selectable integration period	-	-	5s-60m	1s-60m	5s-60m	1s-60m
Indicative memory duration (n days @ PI=10min @ max number of parameters)	-	-	8	90	-	8



I-V500w I-V400w SOLAR I-Ve SOLAR300N PVCHECKs MPP300

»» FOLLOWS

	MAINTENANCE		MAINTENANCE AND EFFICIENCY			
Internal memory extension with Compact Flash card	-	-	-	•	-	-
Default and custom recordings	-	-	-	•	-	-

	MAINTENANCE		MAINTENANCE AND EFFICIENCY			
Summary table of main electric parameters	•	•	•	•	•	-
Voltage/current waveforms	-	-	-	•	-	-
Tables or histograms of Harmonics and THD%	-	-	-	•	-	-
Voltage/current vector diagram	-	-	-	•	-	-

REAL-TIME DISPLAY

Summary table of main electric parameters	•	•	•	•	•	-
Voltage/current waveforms	-	-	-	•	-	-
Tables or histograms of Harmonics and THD%	-	-	-	•	-	-
Voltage/current vector diagram	-	-	-	•	-	-

ADDITIONAL CHARACTERISTICS

Measuring range of curve I-V / Isc-Voc	1500V / 15A**	1000V / 15A	1500V / 15A**	-	1000V / 15A solo Isc-Voc	-
Measuring range for photovoltaic testing	-	-	1000VDC / 265VAC	1000VAC-DC 3000A	-	1000VDC / 600VAC 3000AC / 1000ADC
Measurement category	CAT III 300V	CAT III 300V	CAT III 300V	CAT IV 600V	CAT III 300V	CAT IV 300V
Touchscreen colour display	-	-	-	•	-	-
Backlit LCD display	•	•	•	-	•	-
Internal memory capacity	200 curves I-V	200 curves I-V	200 curves I-V 8 days@ PI=10 min	15MB 90 days@ PI 10min	999 Locations	2MB 8 days@ PI=10 min
USB port for data download onto Pen Drive	-	-	-	•	-	-
Provided PC interface with software for Windows	•	•	•	•	•	-
Built-in WIFI communication interface	•	•	•	-	-	-
Custom management of internal PV module database	•	•	•	-	•	-
Power supply with rechargeable battery and battery charger	-	-	-	•	-	•
Auto power off	•	•	•	•	•	-
Indication of recording duration for photovoltaic testing	-	-	•	•	-	-
Reference standard for mains quality	-	-	-	EN50160	-	-
Help on line on the display	•	•	•	•	•	-
Size (LxWxH) (mm)	235x165x75	235x165x75	235x165x75	235x165x75	235x165x75	300x265x214
Weight in kg (batteries included)	1,2	1,2	1,2	1	1,2	2,3
Reference standard for safety	IEC/EN61010-1	IEC/EN61010-1	IEC/EN61010-1	IEC/EN61010-1	IEC/EN61010-1	IEC/EN61010-1
Order code	HV00500W	HV00400W	HV000IVE	HV00300N	HV00PVCs	HVMPP300

* Optional set of leads KIT KELVIN necessary.

** Only I-V500w and SOLAR I-Ve (max current @1500V=10A, max current @1000V=15A).

ORDER CODE HV00500W | HV00400W | HV0001VE

I-V500w | I-V400w | SOLAR I-Ve

MULTIFUNCTION DEVICES FOR MAINTENANCE AND TROUBLESHOOTING ON PHOTOVOLTAIC INSTALLATIONS



- ▶ Measurement of the I-V curve of one or more modules or of one whole string up to 1500V/15A**
- ▶ Measurement of open-circuit voltage and short-circuit voltage Voc/Isc up to 1500V/15A**
- ▶ Database of 30.000 selectable photovoltaic modules
- ▶ Automatic measurement of more strings in AutoSequence™ mode*
- ▶ Compatible with the App HTAnalysis™ via WIFI

I-V400w allows the **on-site detection of the I-V curve** and of the main characteristic parameters both of a single module and of strings of modules for PV installations up to a maximum of 1000V and 15A.

For measuring the I-V curve, V400w manages an **internal database of the modules, which can be updated at any time by the user**, and comparison between the measured data with the rated values allows immediately evaluating whether the string or the module fulfills the efficiency parameters declared by the manufacturer.

The I-V curve can be measured also by decentralizing measurements of irradiation and temperature by using the optional remote unit SOLAR02, using the radio frequency connection (RF) to the master unit. Also for V400w, **the display at the end of the test of the I-V curve** is a clear indication about the compliance with the specifications declared by the panel manufacturer.

* Optional set of leads KIT KELVIN necessary.

** Only I-V500w and SOLAR I-Ve (max current @1500V=10A, max current @1000V=15A).

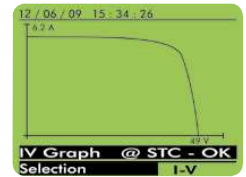

Result of I-V Curve: OK



Manual insertion of a module



Detail of the single results of I-V Curve: OK

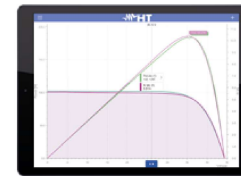

I-V curve and power curve.

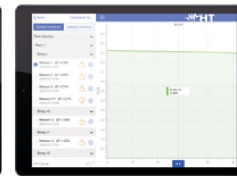

List with measured results.

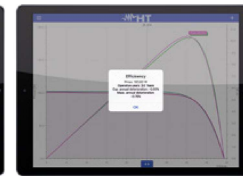

Comparison between foreseen cell deterioration and measured value.

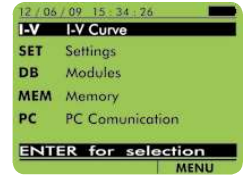

General Menu

Functions

	I-V400w	I-V500w	SOLAR I-Ve
Maintenance of photovoltaic system			
Measurement of PV module/string output voltage	1000V	1500V**	1500V**
Measurement of PV module/string output current	15A	15A	15A
Resolution (spots) of I-V curve in Standard or Capacitive mode	128	128	128
Measurement of Voc-Isc-Pmax-Vmpp-Impp-Fill Factor	•	•	•
Measurement of cell temperature through external feeler	•	•	•
Measurement of irradiation [W/m ²] through reference cell	•	•	•
Measurement of DC and rated power at module/string output	•	•	•
Detection of I-V curve through remote unit SOLAR-02	•	•	•
Measurement of resistance of series Rs of panels	• Max/Min	• Max/Min	• Max/Min
Direct comparison with reference conditions (STC - 1000W/m ² , 25°C)	•	•	•
Test result OK / NO	•	•	•
Internal database for managing up to 30 PV modules (30.000 modules by software)	•	•	•
Internal memory for data saving	•	•	•
Recalling measured data on the display	•	•	•
Optical/USB interface for data transfer onto the PC	•	•	•
Built-in WIFI communication interface	•	•	•
Help on line on the display	•	•	•
Efficiency measurements of the photovoltaic system			
DC/AC TRMS single-phase voltage	-	-	•
DC/AC TRMS single-phase current	-	-	•
Single-phase DC power / AC active power	-	-	•
Solar irradiation [W/m ²] with reference cell HT304N	-	-	•
Panel and environmental temperature through probes	-	-	•
Remote unit SOLAR02 with RF connection	-	-	•
Display of environmental data in real time	-	-	•
Use of compensation relationships Cells/ Environment on Pdc	-	-	•
Parameter recording of a PV system with 5s to 60min programmable IP	-	-	•

Included accessories

SOLAR02	Remote unit for Irradiation and Temperature (SOLAR I-Ve)
KITGSC4	Set of 4 cables + 4 alligator clips
KITPVMC3	Set of 2 adapters with connectors MC3
KITPVMC4	Set of 2 adapters with connectors MC4
HT4005K	Standard 200A AC clamp, diameter 40mm (SOLAR I-Ve)
HT4004N	Standard 10-100A DC clamp, diameter 32mm (SOLAR I-Ve)
HT304N	Sensor for irradiation measurement
PT300N	PT1000 probe for PV modules temperature (SOLAR I-Ve)
M304	Mechanical inclinometer
TOPVIEW2006	Windows software + optical/USB C2006 cable
VA500	Rigid carrying case
	User manual on CD-ROM
	ISO9000 calibration certificate
	Quick guide

Optional accessories

MPP300	Accessory for (AC) three-phase efficiency verification up to (3MPPT) (SOLAR I-Ve)
HT4005N	Standard AC 0÷5A, 0÷100A clamp, diameter 20mm (SOLAR I-Ve)
HT96U	Standard 1-100-1000A AC clamp, diameter 54mm (SOLAR I-Ve)
HT97U	Standard 10-100-1000A AC clamp, diameter 54mm (SOLAR I-Ve)
HT98U	Standard 1000A DC clamp, diameter 50mm (SOLAR I-Ve)
HP30C2	Standard 200-2000A AC clamp, diameter 70mm (SOLAR I-Ve)
HP30C3	Standard 3000A AC clamp, diameter 70mm (SOLAR I-Ve)
HP30D1	Standard clamp, diameter 83mm 1000A DC (SOLAR I-Ve)
SP-0400	Shoulder strap to use the device with free hands
SP-0500	Sheaths to use the device with free hands
KITPVEXT25M	Set of 2 banana cables 4mm, Green/Black, 25m
606-IECN	Connectors with magnetic terminal
KITKELVIN	Test leads for measurements in automatic sequence

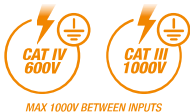

ORDER CODE HV00300N

SOLAR300N

MULTIFUNCTION DEVICE FOR VERIFICATION OF SINGLE-PHASE AND THREE-PHASE PV SYSTEM EFFICIENCY AND POWER QUALITY ANALYSIS IN COMPLIANCE WITH STANDARD EN50160

- ▶ New **touchscreen interface**
- ▶ Verification of the **efficiency** of the photovoltaic system
- ▶ **Analysis of power quality** and **energy consumption**

SOLAR300N tests **single-phase and three-phase photovoltaic systems**. For this kind of tests, it is necessary to guarantee **simultaneity** between power measurements carried out at the inverter and irradiation and temperature measurements carried out on the photovoltaic panels. HT Instruments has introduced a **remote measuring device SOLAR02** which **acquires the values of solar Irradiation [W/m²], panel Temperature [°C] and environmental Temperature [°C]** and transfers them onto SOLAR300N, which inserts them onto the same string of power measurements and then elaborates them with the simultaneity required by the law in force. SOLAR300N is not only a device for testing PV systems, but **also a powerful device for a complete analysis of power quality** according to standard EN50160 (harmonic analysis, voltage anomalies, flickers, unbalance, etc.).



Connection diagram (three-phase system)

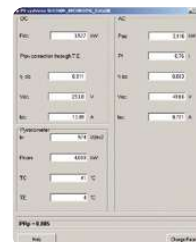

Photovoltaic testing result on PC application TOPVIEW.

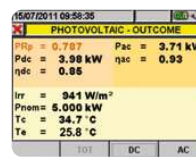

Photovoltaic testing result.



SOLAR300N IS ALSO AN ANALYZER FOR POWER QUALITY AND ENERGY CONSUMPTION

- Harmonics
- Analysis of recordings
- Measurement of energy consumption
- Flicker
- Voltage anomalies and spikes
- Inrush currents
- Vectors and waveforms

Functions

Efficiency measurements of the photovoltaic system

- DC/AC TRMS voltage (single-phase and three-phase)
- DC/AC TRMS current (single-phase and three-phase)
- DC/AC active power (single-phase and three-phase)
- Power factor cosφ (single-phase and three-phase)
- Solar irradiation
- Panel and environmental temperature
- Display of testing result (OK/NOT OK)
- Remote unit SOLAR02 for measuring irradiation and temperature
- Periodic recording of power parameters with programmable PI

Analysis of power and energy consumption

- Recording of voltage and current harmonics (up to the 49th)
- Recording of voltage anomalies (dips, peaks) with resolution 10ms
- Flicker analysis according to EN50160
- Recording of Inrush Currents with resolution 10ms
- Recording of voltage spikes with resolution 5μs
- Complete analysis of power quality according to EN50160
- Touchscreen colour display
- Internal memory and USB output for PC connection
- Power supply with rechargeable Li-ION battery
- Rechargeable internal battery
- Help on line on the display
- Management of USB Pen Drive and compact flash card

Main features

Display:	Colour touchscreen with adjustable brightness
Power supply:	Rechargeable Li-ION, 3.7V battery
Internal memory:	15MB (duration 1 month @ IP=15min, 251 parameters)
External memory:	Compact Flash (CF) card
PC interface:	USB 2.0
Safety:	IEC/EN61010-1
Insulation:	double insulation
Pollution level:	2
Measurement category:	CAT IV 600V (to earth) CAT III 1000V (between inputs)
Unbalance:	IEC/EN61000-4-7
Power quality:	IEC/EN50160
Flicker:	IEC/EN61000-4-15
Reference standard and class:	IEC/EN61000-4-30 Class B
Size:	235x165x75mm
Weight (batteries included):	1kg

Included accessories

SOLAR02	Remote unit for Irradiation and Temperature
KIT800	Set of 5 cables + 5 alligator clips
HT4005K	Standard 200A AC clamp, diameter 40mm (3pcs)
HT4004N	Standard 10-100A DC clamp, diameter 32mm
HT304N	Sensor for irradiation measurement
PT300N	PT1000 probe for PV modules temperature
A0055	External AC/DC battery charger power supply 230V 50/60Hz*
YABAT0003HT1	Rechargeable Li-ION battery
PT400	Touch-screen pen
TOPVIEW2007	Windows software + USB C2007 cable
VA500	Rigid carrying case
	User Manual
	Quick guide
	ISO9000 calibration certificate

(*) Please check accessory line to find the correct power adapter for your country

Optional accessories

MPP300	Accessory for (AC) three-phase efficiency verification up to (3MPPT)
HT4005N	Standard AC 0÷5A, 0÷100A clamp, diameter 20mm
HT96U	Standard 1-100-1000A AC clamp, diameter 54mm
HT97U	Standard 10-100-1000A AC clamp, diameter 54mm
HT98U	Standard 1000A DC clamp, diameter 50mm
HP30C2	Standard 200-2000A AC clamp, diameter 70mm
HP30C3	Standard 3000A AC clamp, diameter 70mm
HP30D1	Standard clamp, diameter 83mm 1000A DC
HTFLEX33E*	Flex 3000A clamp, for power analysis, diameter 174mm
HTFLEX35*	Flex 3000A clamp, for power analysis, diameter 274mm
HT903	3x1-5A/1V box for TA connection
SP-0400	Shoulder strap to use the device with free hands
606-IECN	Magnetic connectors for voltage measurement
A0056	115V/50-60Hz power supply with American plug
CF800	1Gb Compact flash card
MCR800	Compact flash card reader

(*) can be used only for power analysis



ORDER CODE HV00PVCS

PVCHECKS

MULTIFUNCTION DEVICE FOR COMMISSIONING TESTS OF ELECTRIC SAFETY AND PERFORMANCE OF A PHOTOVOLTAIC SYSTEM

Automatic test in a sequence of:

- **Measurement of insulation** up to 1000V DC
- **Open-circuit voltage** and **short-circuit current Voc/Isc**
- **Continuity of protective conductors** with 200mA

The multifunction device PVCHECKS allows quickly and safely carrying out the commissioning tests provided for a PV system (section in DC) and the functional test of modules/strings the system consists of according to the requirements of Standard IEC/EN62446.

When testing safety, PVCHECKS is a real innovation, since it is capable of measuring insulation of a module, string or of a whole photovoltaic field (IEC/EN62446) with no need to use an external switch to short-circuit the positive and negative terminals.

PVCHECKS also allows checking the functionality of the connections and of the strings in a photovoltaic field, according to the provisions of standard IEC/EN62446 by measuring the open circuit voltage and the short-circuit current at operating conditions (OPC) and referred to STC (via the optional measurement of irradiation, also with the use of optional accessories SOLAR02 and HT304N), providing an immediate result as regards the measurement just carried out, both in absolute terms and by comparison with the previously tested strings. Finally, PVCHECKS also allows analyzing the performance of the photovoltaic field (DC) under operating conditions (therefore connected to the inverter) with the use of optional accessories SOLAR02 and HT304N, providing an indication of the generated power and of the performance of the field itself.

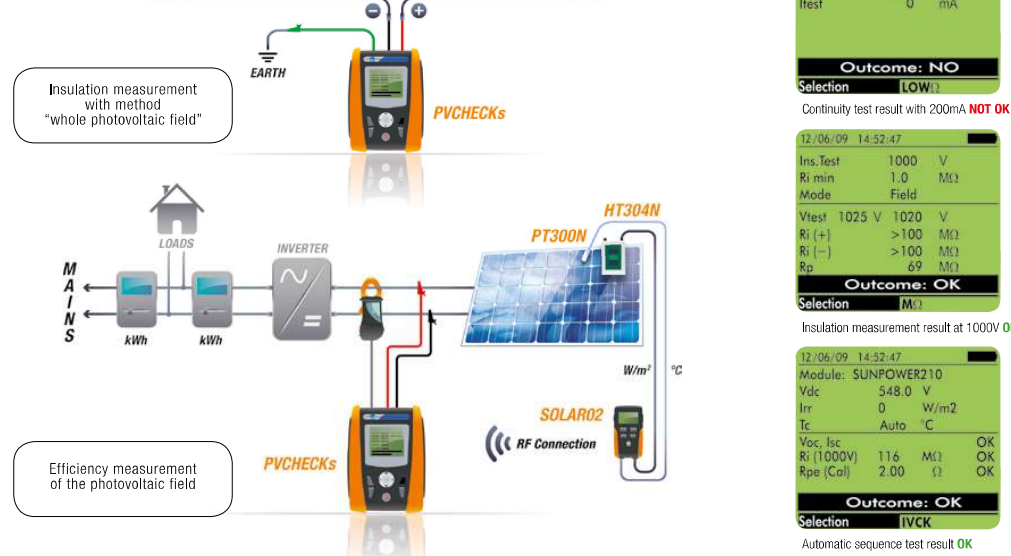
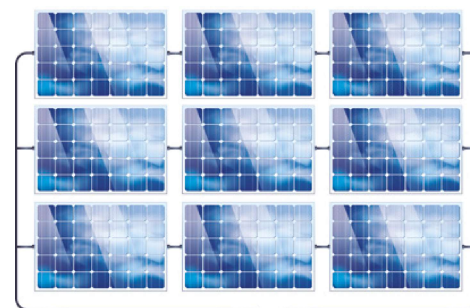

Functions

Maintenance of photovoltaic system

- Continuity of protective conductors with test current 200mA
- Insulation measurement with test voltage 250,500 and 1000VDC
- Open-circuit voltage (VOC) measurement up to 1000V DC
- Short-circuit current (ISC) measurement up to 15A DC
- DC voltage - DC current - DC power measurement
- Measurement of irradiation [W/m²] through reference cell HT304N
- Environmental and photovoltaic module temperature measurement through PT300N probe
- Use of compensation relationships Cells/Environment on Pdc
- Measurements always compared to the values declared by the module's manufacturer
- Internal database for managing up to 30 PV modules (30.000 modules by software)
- Test measurement of string operation
- Mechanical inclinometer for verifying the correct inclination of sun rays
- Result for every measurement OK/NO
- Internal memory and USB output for PC connection
- Help on line on the display

Efficiency measurements of the photovoltaic system

- Efficiency measurement of the photovoltaic field (DC side)

Main features

Display:	LCD, 128x128pxl, with backlight
Power supply:	6x1.5V alkaline batteries type AA LR06
Auto power off:	after 5 minutes
Internal memory:	256kBytes
PC interface:	optical/USB
Safety:	IEC/EN61010-1
Safety of accessories:	IEC/EN61010-0:31
Measurements:	IEC/EN 62446
Insulation:	Double insulation
Pollution level:	2
Overvoltage category:	CAT III 1000VDC (to earth) Max 1000V between inputs
Size:	235x165x75mm
Weight (batteries included):	1.2kg

Included accessories

HT4004	Standard 10-100A DC clamp, diameter 30mm
KITGSC4	Set of 4 cables + 4 alligator clips
KITPCMC3	Set of 2 adapters with connectors MC3
KITPCMC4	Set of 2 adapters with connectors MC4
TOPVIEW2006	Windows software + optical/USB C2006 cable
BORSA2051	Soft carrying bag
	ISO9000 calibration certificate
	User manual and quick guide

Optional accessories

PT300N	PT1000 probe for PV modules temperature
SOLAR02	Remote unit for Irradiation/Temperature measurement
HT304N	Reference cell for irradiation measurement
M304	Mechanical inclinometer
SP-0400	Shoulder strap to use the device with free hands
KITPVEXT25M	Set of 2 banana cables 4mm, Green/Black, 25m
606-IECN	Connectors with magnetic terminal

YouTube



ORDER CODE HVMPP300

MPP300

ACCESSORY FOR MEASURING AND RECORDING THE EFFICIENCY OF A SINGLE- AND THREE-PHASE, SINGLE- AND MULTI-STRING PHOTOVOLTAIC SYSTEM (UP TO THREE MPPT).

- › Simultaneous analysis of **3 strings**
- › **Compatible** with SOLAR300N and SOLAR I-Ve
- › **Integrated rechargeable battery**

MPP300 is an innovative accessory which allows **measuring and recording the main parameters** which characterize single and three-phase, single and multi-string photovoltaic systems (up to three MPPT). Provided with a practical **rigid anti-shock case**, thanks to its **lightness** and its **reduced size** is the ideal solution for on-site use. MPP300 **interfaces** with SOLAR300N and SOLAR I-Ve for its settings, to start/stop recording electric and environmental parameters and to allow for the download of the recorded values. The master devices SOLAR300N or SOLAR I-Ve are only used in the initial and final phase of recording, and they do not play any active role while recording electrical and environmental parameters. Remote unit SOLAR02 (**synchronized** with MPP300) is positioned next to the photovoltaic modules to measure environmental parameters (**irradiation and temperature**). Thanks to this synchronization, **it is not necessary to place long connection cables between the environmental probes and the device** (cables which would impair the operator's movements) **nor to use a wireless connection** between the environmental probes and the device, what is generally impossible due to the attenuation of the signal caused by the presence of floors, reinforced concrete or metal structures.

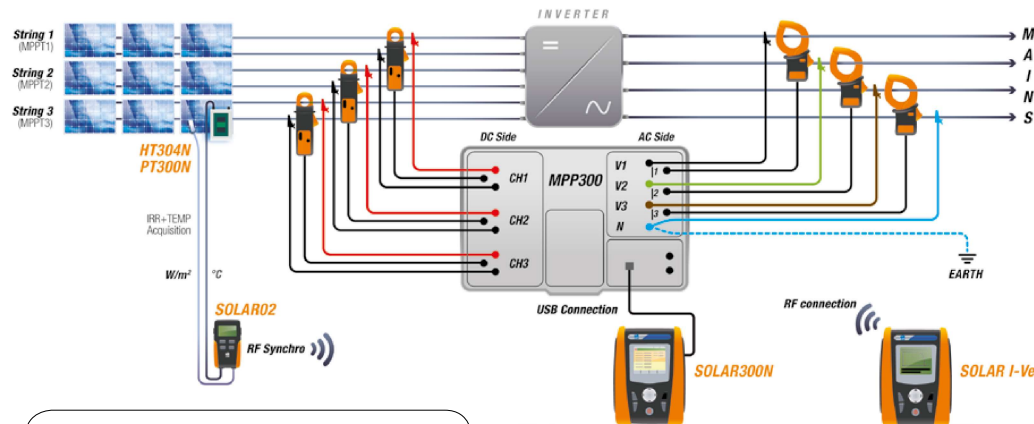

Connection examples:
 › MPP300 + SOLAR300N with USB connection
 › MPP300 + SOLAR I-Ve with RF wireless connection

Synchronization between the two units **guarantees the necessary simultaneity of measurements** and the two separate and independent units make **measurements comfortable and safe under any condition**. MPP300's **best partner is SOLAR I-Ve**: while MPP300 records the electrical and environmental parameters, it is possible to measure the I-V curves of strings and modules with SOLAR I-Ve, **thus saving time and money**.



- › Practical rigid anti-shock case
- › Small size (mm 300x265x140) for an extreme portability

Functions

- DC/AC TRMS voltage measurement (single-phase and three-phase)
- DC/AC TRMS current measurement (single-phase and three-phase)
- DC/AC power measurement (single-phase and three-phase)
- Simultaneous multi-string tests (max 3 MPPT)
- Connection with master unit SOLAR300N and SOLAR I-Ve
- Power supply with rechargeable Li-ION battery
- LED operating indications
- USB port for connection to unit SOLAR300N
- RF connection for connection to SOLAR02 and SOLAR I-Ve
- Internal memory for saving recordings

Main features

Inputs:	3 DC voltage inputs (CH1, CH2, CH3), 3 DC current inputs (CH1, CH2, CH3), 4 AC voltage inputs (L1, L2, L3, N), 3 AC current inputs (L1, L2, L3)
Front panel:	4 two-colour LEDs (red, green)
Power supply:	Rechargeable Li-Ion battery Duration >3 hours
Internal memory:	2 MBytes
Communication interfaces	USB + RF
Safety:	IEC/EN61010-1
Insulation:	double insulation
Pollution level:	2
Mechanical protection:	IP40 (open), IP65 (closed)
Measurement category:	CAT IV 300 VAC (to earth), 600 VAC (between inputs) CAT III 1000 VDC (to earth), 1000 VDC (between inputs)
Size:	300x265x140mm
Weight (batteries included):	2.3 kg

Included accessories

KITMPPDCW	Set of 2 cables, red and black banana-banana length 2m, 3 pieces
KITMPPDCC	Set of 2 alligator clips, black and red, 3 pieces
KITMPPACW	Set of 4 cables for AC voltage, 2m
KITMPPACC	Set of 4 alligator clips for AC voltage
A0055	External AC/DC battery charger power supply
C2007	USB cable
ACON3F4M	Adapter for the connection of clamps HT98U, HP30D1 and HT4004N, 3 pieces
BORSA2051	Soft carrying bag for accessories
	User Manual
	ISO9000 calibration certificate

Optional accessories

HT4004P	Standard 10-100ADC clamp, diameter 32mm (only MPP300)
HT4005N	Standard AC 0±5A, 0±100A clamp, diameter 20mm
HT4005K	Standard 200A AC clamp, diameter 40mm
HT96U	Standard 1-100-1000A AC clamp, diameter 54mm
HT97U	Standard 10-100-1000A AC clamp, diameter 54mm
HT98U	Standard 1000A DC clamp, diameter 50mm
HP30C2	Standard 200-2000A AC clamp, diameter 70mm
HP30C3	Standard 3000A AC clamp, diameter 70mm
HP30D1	Standard clamp, diameter 83mm 1000A DC
HTFLEX33E	Flex 3000A clamp, for power analysis, diameter 174mm
HTFLEX35	Flex 3000A clamp, for power analysis, diameter 274mm
606-IECN	Magnetic connectors for voltage measurement